









INTERIOR DOOR SYSTEMS

2003 Steel Framed Series







Steel Bottom Roll Mirror or Glass Bypass Doors



Steel Framed Finishes

	SATIN GOLD (SG)		ARCTIC SILVER (AS)
	BRIGHT WHITE (BW)		MATT BLACK (MB)
	BRIGHT GOLD (BG)		VANILLA (VA)
	ARCHITECTURAL BROWN (AB)		POLISHED BRASS (PB)
	NICKEL (NI)		SATIN NICKEL (SN)

Glass Options

	CLEAR MIRROR Safety-backed 3mm		SMOKED MIRROR Safety-backed 3mm
	BRONZE MIRROR Safety-backed 3mm		RED BACK PAINTED GLASS Safety-backed 3mm
	WHITE BACK PAINTED GLASS Safety-backed 3mm		BLACK BACK PAINTED GLASS Safety-backed 3mm

Product Description

- Bottom roll system with built in anti-jump feature
- Standard sizes fit 4', 5', 6' widths and finished opening heights of 79-3/4" - 80-3/4" and 95-1/2" - 96-1/2" (+/- 1/4" adjustment)
- Factory finished, ready-to-install
- Custom sizes made to order

Stile Profile

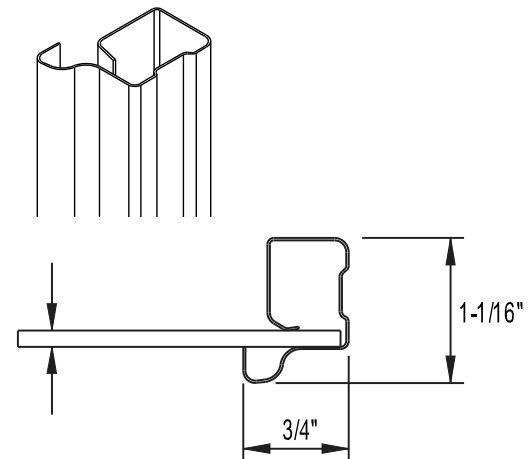

Featuring



2003 Steel Framed Series Steel Bottom Roll Mirror or Glass Bypass Doors

Sliding closet doors shall use **2003 Steel Framed Series** hardware consisting of steel framed door panels and shall be supported by adjustable bottom rollers that travel in a steel bottom track and top guides that travel in a steel top track.

The steel frame shall consist of stiles (vertical member) with an integral pull and rails (horizontal member).

The stiles and rails shall be joined at each corner by unhandled connectors that snap into position, are positively fastened, but can be removed for changing of inserts. Bottom connectors shall have either ball bearing rollers or solid acetal plain bearing wheels both with an integral anti-jump housing. Top connectors shall have a solid plastic guide permanently attached to the connector housing which provides a snug fit with the top track. The plastic guide will adjust to five different positions to ensure an optimum fit. Vertical adjustment is 1-1/8" (29mm) on the bottom and 1-1/4" (32mm) on the top.

The top track shall be one piece and of pre-finished steel. The bottom track shall be pre-finished steel and not exceed 5/16" (8mm) from the floor. Both top track and bottom track finishes shall match the stile and rail.

The stile, rail, top track and bottom track shall have a baked enamel paint finish (satin gold, bright gold, bright white, matt black, arctic silver, architectural brown, vanilla or nickel) or plated (polished brass). The connectors shall be plated.

Insert thickness: 1/8" to 5/32" (3mm to 4mm)

Maximum single door size: 48" wide x 96" high (1219mm x 2438mm)

Maximum single door weight: 85 lbs. (38kg)

Finished Door Opening Heights: Standard 80 1/2" (door range: 79 3/4" to 80 3/4"), standard 96" (door range: 95 1/2" to 96 1/2")

Finished Door Opening Widths: Standard widths of 48", 60", 72", 84", 96", 108", 120", 144", 192". Custom sizes available up to 192"w x 96"h

All JJ® mirror products use safety backed mirror. The mirror conforms to CGSB 12.5-M86 Type 3C (Canada) and ANSI Z97.1-1984 (US)

Cross Sectional

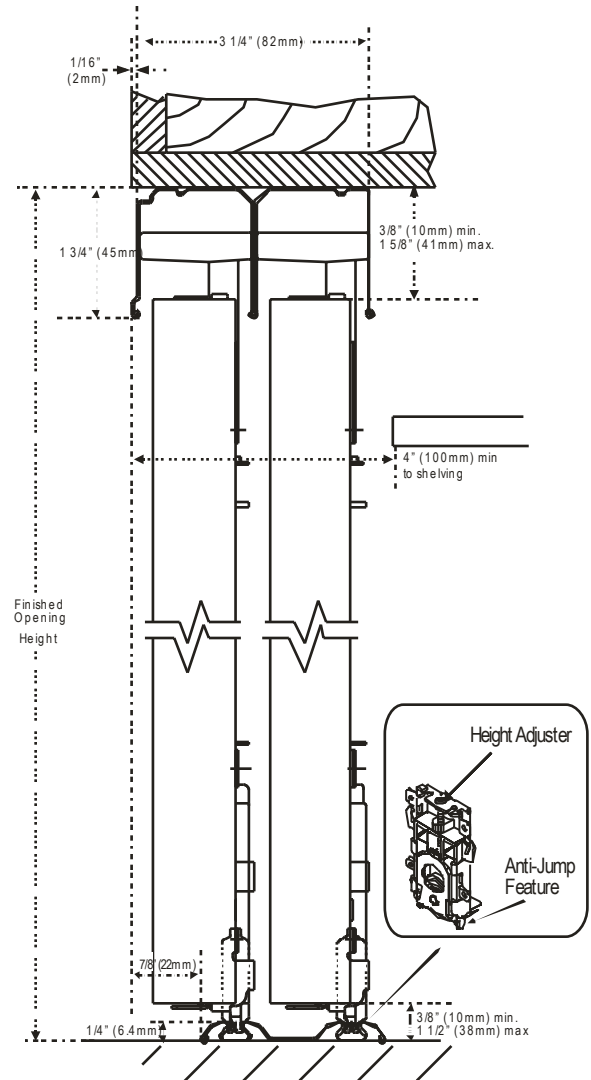

Featuring

